

# Rescue Sheet & Associated document Guidelines for Cars

Post-Crash

## Technical Bulletin PC 101-1

Implementation January 2026

## **PREFACE**

DISCLAIMER: Euro NCAP has taken all reasonable care to ensure that the information published in this protocol is accurate and reflects the technical decisions taken by the organisation. In the unlikely event that this protocol contains a typographical error or any other inaccuracy, Euro NCAP reserves the right to make corrections and determine the assessment and subsequent result of the affected requirement(s).

# CONTENTS

|   |           |
|---|-----------|
| <b>1 GENERAL</b>  | <b>4</b>  |
| <b>2 GENERAL RECOMMENDATIONS</b>                            | <b>5</b>  |
| 2.1 Colour Codes from ISO                                   | 5         |
| 2.2 Pictograms from ISO 17840                               | 5         |
| 2.3 Translations  | 5         |
| <b>3 FRONT PAGE LAYOUT AND CONTENT</b>                      | <b>6</b>  |
| 3.1 Header - Part 1   | 6         |
| 3.2 Header - Part 2   | 7         |
| 3.3 Legend  | 16        |
| 3.4 Footer  | 17        |
| <b>4 ADDITIONAL PAGES LAYOUT AND CONTENT</b>                | <b>18</b> |
| 4.1 General   | 19        |
| 4.2 Chapter 1 – Identification / Recognition                | 19        |
| 4.3 Chapter 2 – Immobilisation / Stabilisation / Lifting    | 20        |
| 4.4 Chapter 3 – Disable Direct Hazards / Safety Regulations | 21        |
| 4.5 Chapter 4 – Access to the Occupants                     | 25        |
| 4.6 Chapter 5 – Stored Energy / Liquids / Gases / Solids    | 27        |
| 4.7 Chapter 6 – In Case of Fire                             | 28        |
| 4.8 Chapter 7 – In Case of Submersion                       | 30        |
| 4.9 Chapter 8 – Towing / Transportation / Storage           | 30        |
| 4.10 Chapter 9 – Important Additional Information           | 31        |
| 4.11 Chapter 10 – Explanation of Pictograms Used            | 31        |
| <b>5 ERG – EMERGENCY RESPONSE GUIDE</b>                     | <b>32</b> |
| 5.1 Overview of ERG headings                                | 32        |
| 5.2 Emergency Response Guide - Chapter 0                    | 33        |
| 5.3 Emergency Response Guide - following chapters           | 33        |
| <b>6 RESCUE SHEET &amp; ERG - FILE NAMING</b>               | <b>35</b> |

# 1 GENERAL

The purpose of this document is to specify and illustrate how to design the content and layout of a Rescue Sheet in accordance with ISO 17840 standard (Part 1, as well as Part 3 and Part 4). Following these instructions, the rescue sheet will be compliant with current Euro NCAP requirements.

Examples included (labelled “EXAMPLE” in the text) can come from official rescue sheets or they can be made up to illustrate a point and present best practice solutions. No rights can be derived from these examples.

The purpose of the Rescue Sheet format is to use as less text as possible in order to make their understanding as easy as possible and overcome language barriers. The rescue sheet (ISO 17840 Part 1) is “quick information” for the first responders on the accident scene.

The ISO 17840 Part 3 Emergency Response Guide (ERG) gives “in-depth information” by adding text in addition to the pictures or the pictograms from the Rescue Sheet. The ERG contains crucial and in-depth information linked to the Rescue Sheet to inform, train, and develop rescue procedures by first responders. The headings/contents of the Rescue Sheet and the ERG information are aligned with each other, i.e. the ERG information works as an extension to the Rescue Sheet.

Both ERG and the Rescue Sheet follow a flowchart of the main actions to take by first and second responders, arriving at the accident scene or performing towing and other activities afterwards.

In this technical bulletin the main requirements for an ERG are explained showing how it must follow ISO 17840 Part 3 requirements. Also, examples of energy disabling labels attached to vehicle components, mentioned in the rescue sheet and ERG, are illustrated.

In order to assist Euro NCAP with the handling of the large number of rescue sheets now required from 2023 onwards for each model assessed, the correct file naming of each sheet when submitted by the OEM is explained near the end of this document.

*(OEMs should note that the rescue sheet examples used in this document are used to highlight one specific requirement and other items contained within the example sheet may not be fully ISO 17840 compliant).*

## 2 GENERAL RECOMMENDATIONS

It is recommended to use as little text as possible, and instead use the pictograms defined in ISO 17840 – Part 1 and/or Part 3. This way, this information is straightforward for the first responders, and the effort to edit versions in all the different languages will be less.

- Always use pictograms coming from ISO 17840-Part 1 and/or Part 3. Seek expert advice if you are uncertain about which pictogram to use.
- Ensure the quality of the picture / drawings / photos / pictograms are following the General Recommendations in ISO 3864-1. This is to make certain that the document is readable and easy to understand.
- Important information must be emphasized:
  - Hazards/Danger: **Red border** RGB: 255/0/0, text in black capital letters or lower case.
  - Recommendation: **Green border** RGB: 0/176/80, text in black capital letters or lower case.

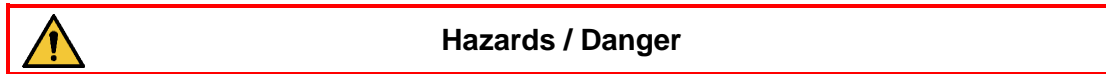

### 2.1 Colour Codes from ISO

Pictograms are made with specific shape, pattern but also colour. The use of each colour and its RGB code is defined by ISO 17840. To understand and classify the parts, equipment, and dangers at first glance, it is important that the ISO colour codes are respected.

### 2.2 Pictograms from ISO 17840

For ISO 17840 Part 1, 2 and 3 (used in the legend), it is possible to buy the full package of pictograms (in vector and high-resolution bitmaps) from the SIS site:

<https://www.sis.se/en/bcker/rescue-sheets-and-emergency-response-guides-for-road-vehicles/>

The propulsion energy labels (diamond form) in ISO 17840 Part 4 are all made by a combination of symbols that are defined in ISO 7000. Each symbol has a registration number and ISO 17840 Part 4 defines which symbol(s) need to be used for each propulsion energy.

All the ISO 7000 symbols can be found at [www.iso.org/obp](http://www.iso.org/obp), click “graphical symbols” and enter the number of the desired symbol. Symbols in vector format can be purchased and downloaded directly.

### 2.3 Translations

ISO 17840 Part 1, 2, 3 and 4 defines the format of the rescue sheet and the pictograms to be used. The standard also specifies the name of the part represented by these pictograms.

Even if the idea is to use as little text as possible, there is a need to translate the rescue sheet in different languages. For this, the members of the Euro NCAP and ISO Rescue working groups also provided recommended translation of the pictograms present in the Legend, see Appendix.

A separate file “Annex to TB030 - Translation of pictograms and headers for ISO\_17840” can be downloaded from the Euro NCAP website. This file will be updated regularly.

### 3 FRONT PAGE LAYOUT AND CONTENT

The front page of the ISO Rescue sheet presents the main information and is organised in several blocks/parts:



- Header (Part 1), including brand and vehicle information, etc.
- Header (Part 2), including perspective views of the vehicle (photos or virtual representations).
- Body, including top and side views of the vehicle (drawings) with pictograms used to locate relevant components and functions.
- Legend, with standardised pictograms and text.
- Footer.

In the next sections, more detailed comments are provided on each part.

#### 3.1 Header - Part 1

Check the following:

- 1) Both brand name and model name are listed, even if the logo shows the brand in full letters.

|   |  |  |
|---|--|--|
|  | <p><b>LEXUS RZ450e</b><br/>5 doors / 5 seats / wagon<br/>2023-01</p> |  |
|---|--|--|

- 2) Do not forget to check if the commercial (as advertised) name of the model (or brand) is not different in one specific country/market.
- 3) List all body types of the model covered by this rescue sheet. For example: 3 doors-5 doors, 5 seaters vs 7 seaters, hatchback, sedan...
- 4) Use approved symbols for propulsion energy identification only, according to ISO 17840 - Part 4:

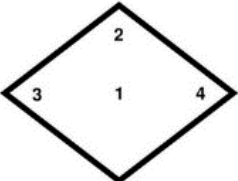
|   |                         |
|---|-------------------------|
|  | 1. First energy source  |
|   | 2. Second energy source |
|   | 3. Density towards air  |
|   | 4. Stored state         |

#### EXAMPLES





5) Use one of these pictograms, or leave blank: (LHD) (RHD)

Never put the 2 pictograms at the same time! Purpose of this pictogram is to inform that the RHD rescue sheet contains significant differences from the LHD version and therefore 2 distinct Rescue Sheets are needed. In most of the vehicles this distinction is not needed. **Therefore, the pictogram must not be used if there is no need for a second Rescue Sheet for the other hand of drive.**

### 3.2 Header - Part 2

Ensure the quality of the (colour) image is minimum 300 dpi and the size of the pictures is large enough to be able to distinguish the details for a first responder trying to identify the car to ensure this is the right Rescue Sheet.

Please check the following:

- 1) ISO standard asks for 2 pictures, not less, not more.
- 2) The image can be a photo of the real car, or a digital, virtual representation of the car model with a plain background (no roads, buildings, trees, people etc. as below).

#### EXAMPLE



### 3.2.1 Top and Side Views

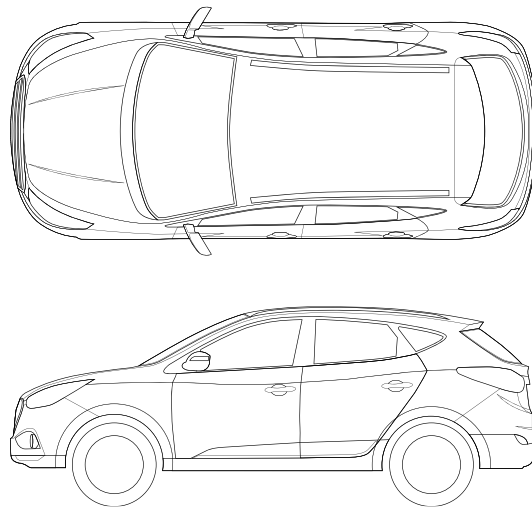

Please check the following:

- 1) It is mandatory that any vehicle outline diagrams are shown with black lines.
- 2) It is recommended that a simple vehicle outline drawing is used rather than a modified picture/graphic of the car. Not all of the styling details/lines need to be shown on the vehicle diagram as space should be available to show all of the important components relevant to rescue.
- 3) In the top view the outline of the dashboard/facia and steering wheel must be present. (If airbags are also shown in the side view these dashboard/facia outlines must also be present).
- 4) The outline (very basic transparent drawing) of the seats should be shown in the top and side views.
- 5) It is recommended to represent the different types of airbag with an appropriate size and form in the undeployed state.
- 6) Use the pictograms as shown in the legend. If you need to use pictograms from Part 3, do not forget to display them in the legend (see dedicated section).
- 7) Do not deform (stretch) existing symbols but when the volume is important draw realistic adapted components keeping the colour code of the symbol/border strip (e.g., HV battery).

The following illustrations explain the above requirements:

Do not stretch the pictogram

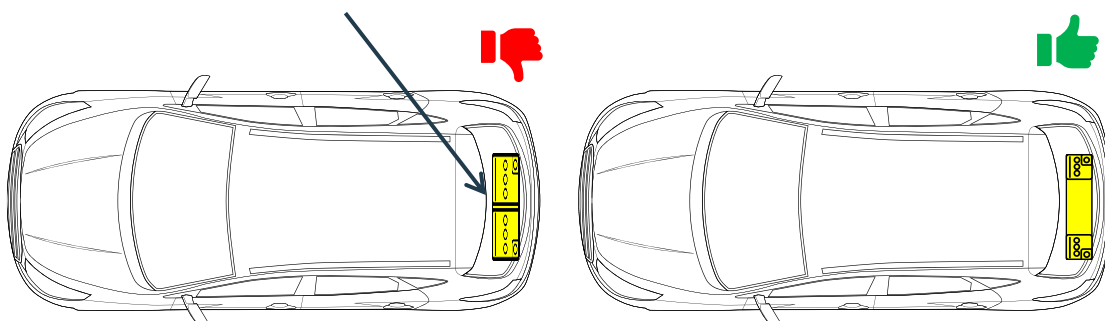



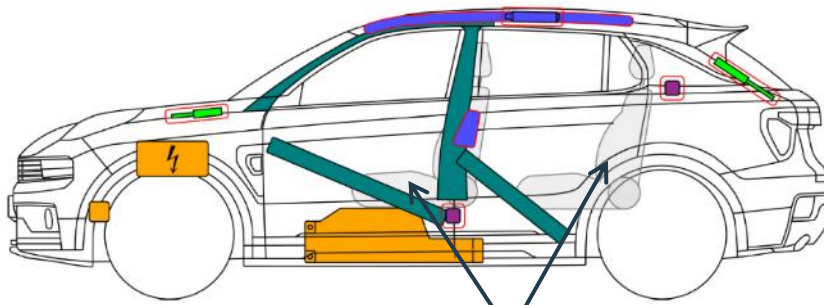

Show seating

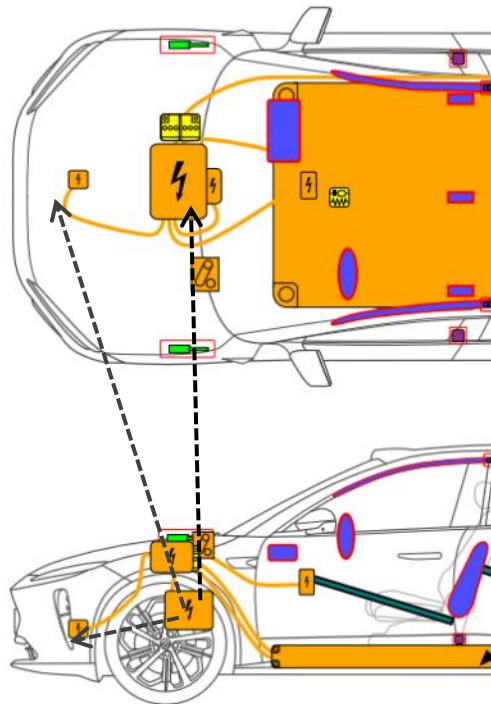

Flash may be omitted in case of space constraints on some of the smaller HV component pictograms, and also does not need to be shown on both top and side views, one view is enough.

Draw realistic shape components (e.g. airbags, HV battery, fuel tanks) especially HV components under the bonnet or boot if it helps to quickly recognise the important components by the rescuers.

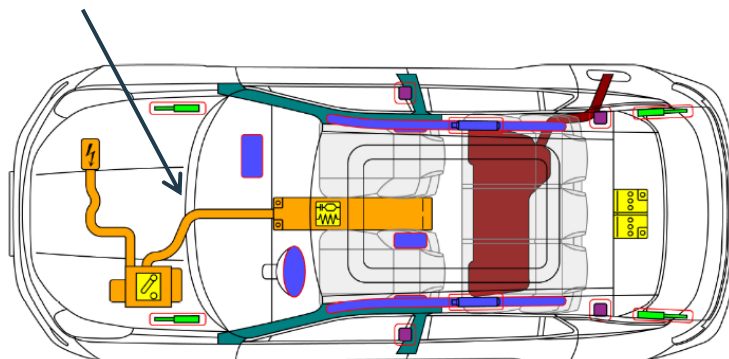

Do not show unnecessary components that are not relevant for the rescue operation.

However, dashboard/facia outline and steering wheel contour are useful to understand the equipment pictograms, therefore they must be present in the top view.

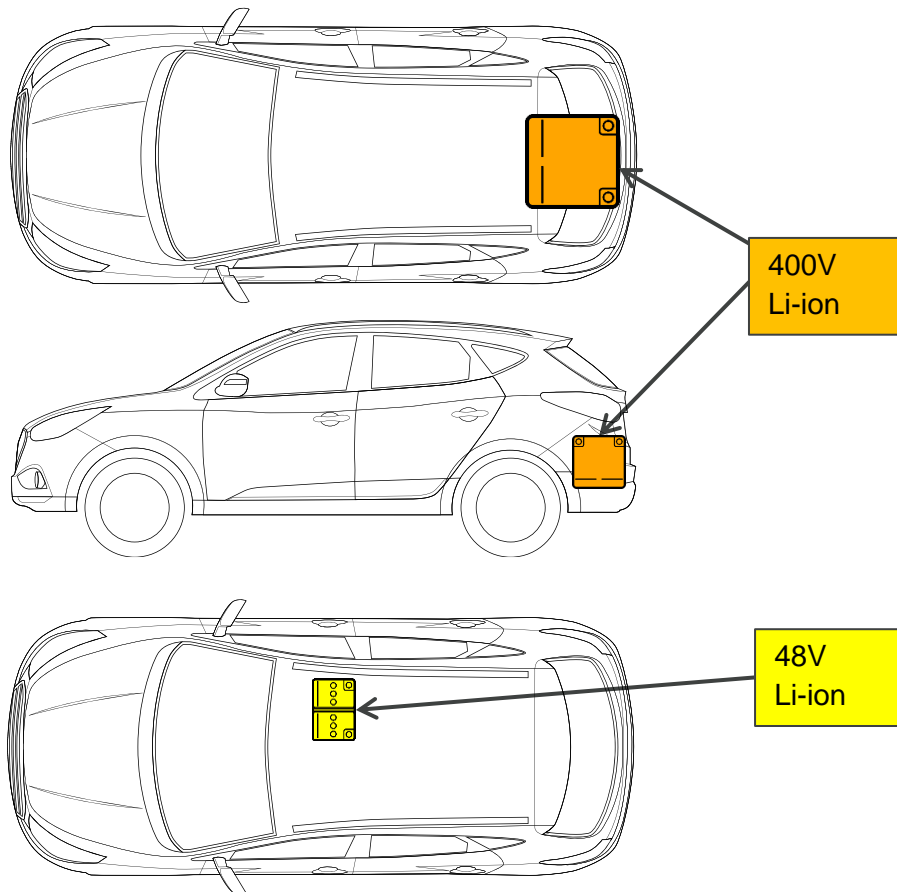

The HV voltage & battery type (in this order) must be indicated with an arrow pointing towards the battery pictogram and a text box using the same colour code as the pictogram. This requirement is also applicable for low voltage batteries (from 24V to 60V).

### 3.2.2 Double Frame Rectangle

A double frame rectangle should be present on the top or side view. To highlight specific items, you must combine the double frame rectangle with the reference to the chapter number together with its colour code.

It is also permitted by ISO 17840 Part 1 to show this double frame rectangle on the vehicle perspective view in the Header Part 2. However, Euro NCAP recommends using the top or side views. It is recommended to use this double frame rectangle for any new equipment, or unusual location of equipment that the first responders may not be used to seeing in the vehicles.

Use the double frame rectangle with the reference to the chapter number together with its colour code:

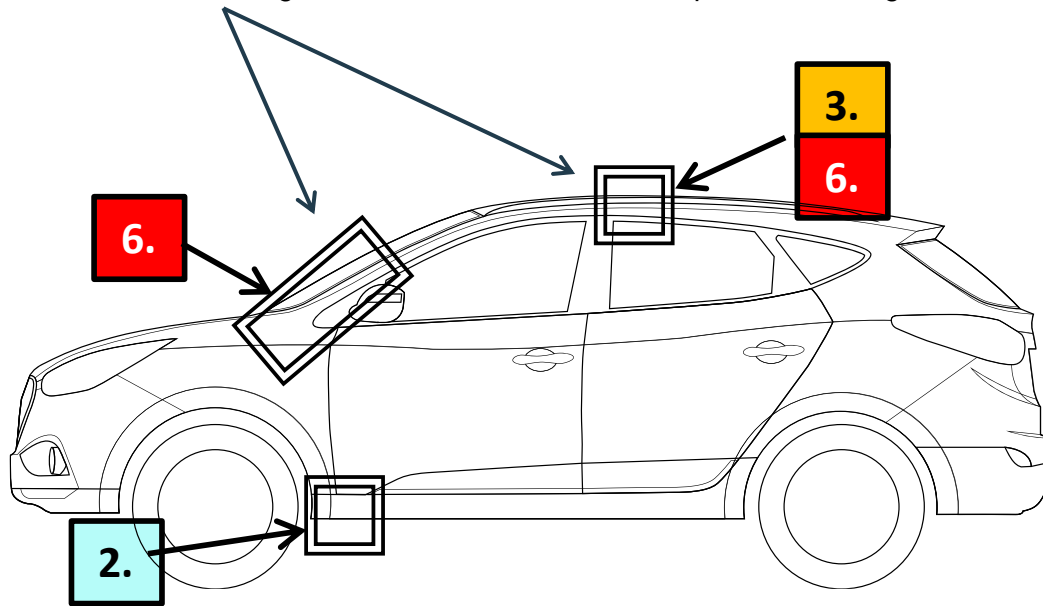

### 3.2.3 Car Contact shut off to deactivate HV system



In order to represent the instruction to use the engine/motor ON/OFF button to deactivate the HV system some manufacturers use the “low voltage disconnect high voltage device” pictogram. However, Euro NCAP does not recommend using this pictogram on the first page for a simple ON/OFF button as some first responders may search for a dedicated device.

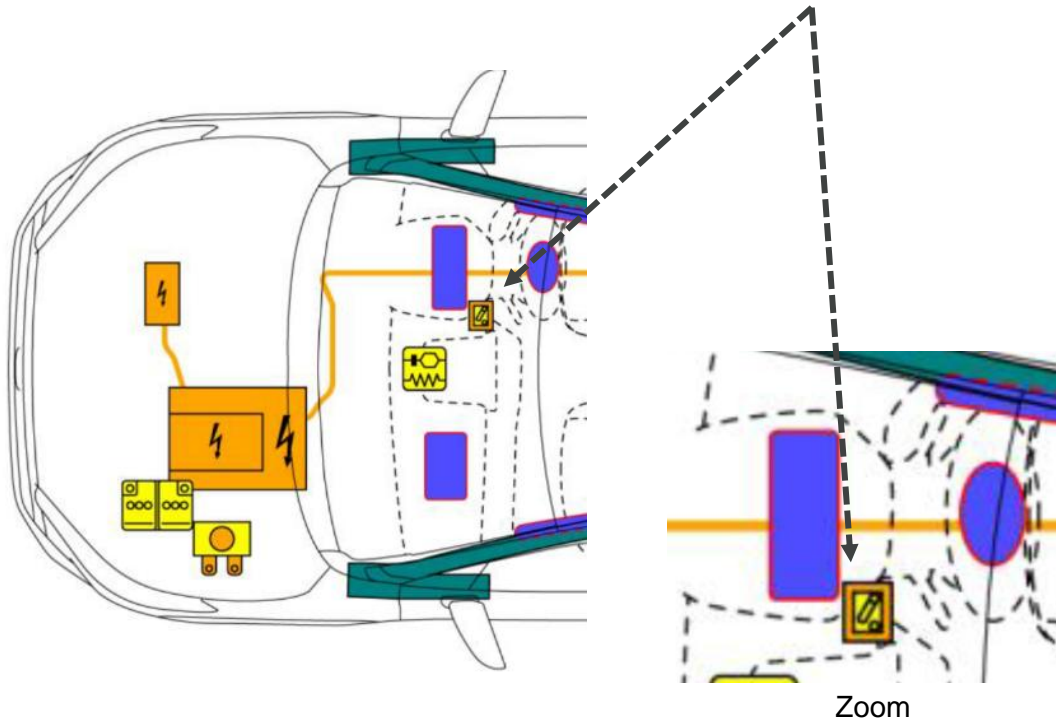

Also, this pictogram should not be present in chapter 3 if there is no specific disabling device is present:

<Main Procedure>

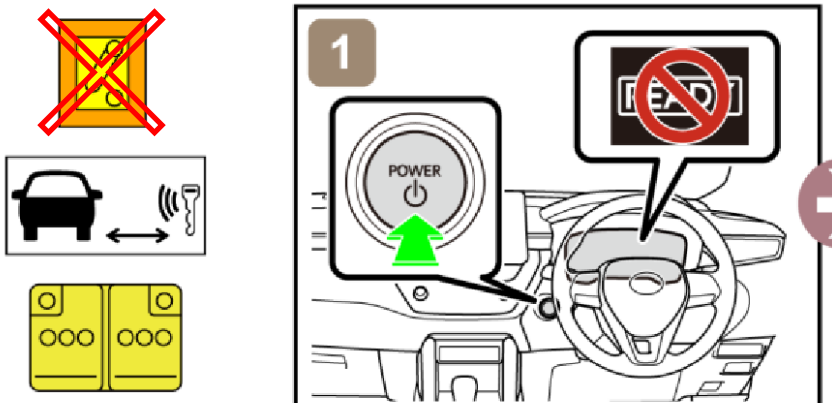

### 3.2.4 Gas Strut

The Red colour code has been initially reserved for actively triggered equipment only (e.g., via pyrotechnic) as shown in Table 1. However, gas struts have traditionally been displayed in the Rescue Sheets with a red contoured pictogram and first responders are used to see this equipment displayed in this way.

Initially, before ISO 17840 creation, the red contour was used to distinguished between a pre-loaded spring and a gas-strut. This distinction was considered crucial because in case of fire the gas strut can be a real danger compared to a pre-loaded spring. For this reason, the ISO Working Group has decided to change the definition of the red colour code, to keep the red contour for any gas strut in the ISO 17840 Part 1 new version (publication pending).

Check the following:

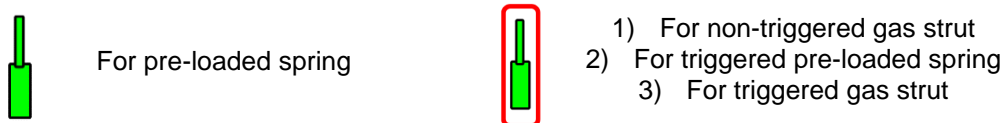

In the example below the standard gas strut pictogram can be used to illustrate the presence of a transverse gas damper when the OEM states that it is needed to alert the first responders.

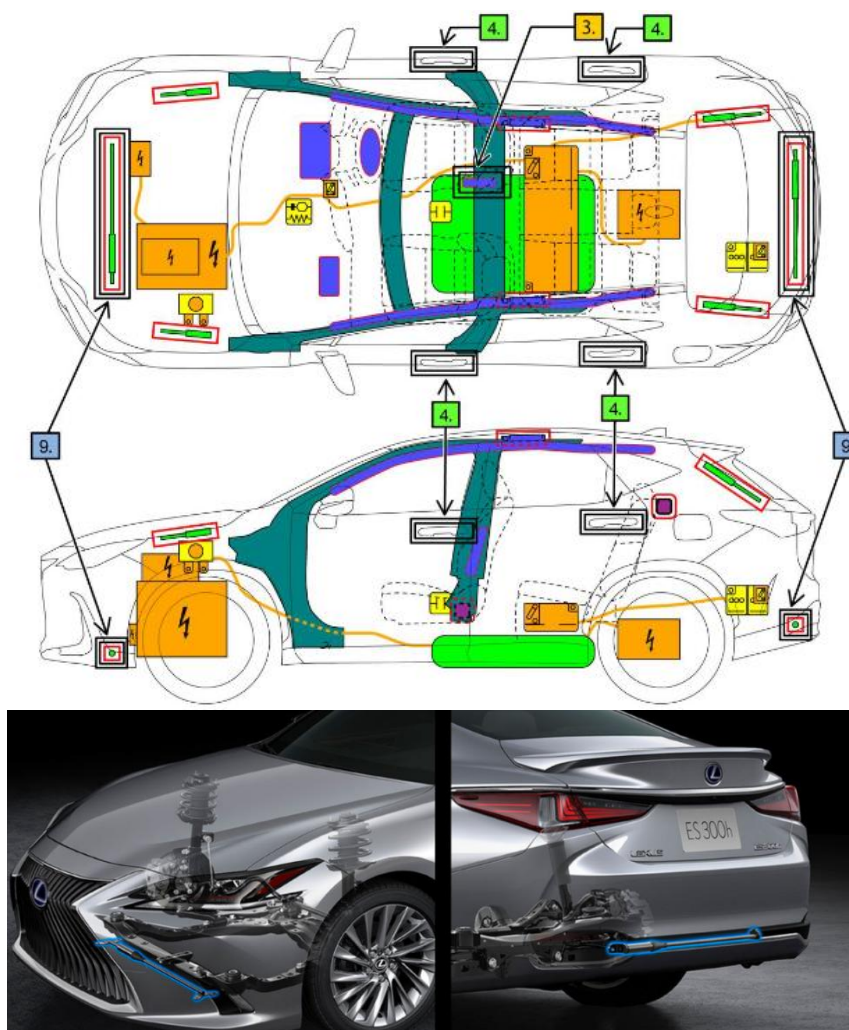



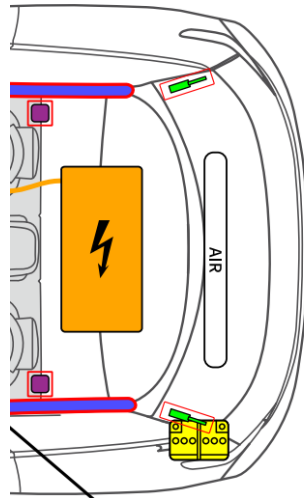



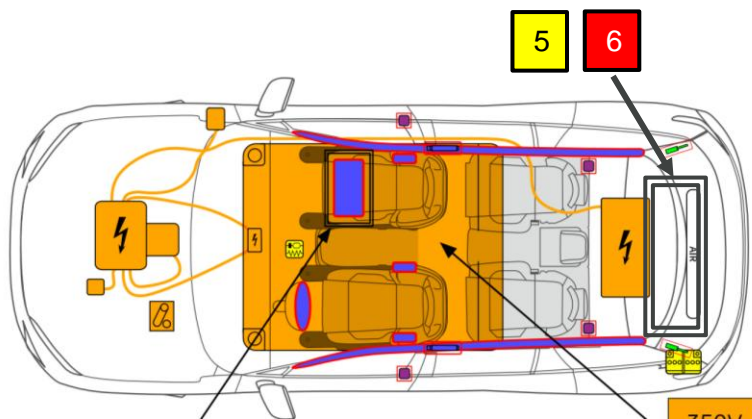





### 3.2.5 Compressed Air Tank (e.g. for air suspension)



This tank can lead to cold explosion, for this reason it is needed to warn about it in chapter 5 and in chapter 6 of the Rescue Sheet. This is done with the double frame rectangle.



The pictogram needs to be added to the legend since it is displayed in the first page.

|   |  |   |  |
|---|--|---|--|
|  Airbag                              |  Stored gas inflator                              |  Seat belt pretensioner  |  SRS control unit                 |
|  Battery low voltage                 |  Gas strut /Preloaded spring                      |  High strength zone      |  Zone requiring special attention |
|  Air tank                            |  Low voltage device that disconnects high voltage |  High voltage disconnect |  High voltage battery pack        |
|  High voltage power cable /component |  |   |  |

### 3.2.6 Pedestrian - Active hood

In some cases, the symbol  is used as a generic information to illustrate the presence of the active hood. In other cases, it is used to show the location of each of the pyrotechnic components. Either of these 2 illustrations is acceptable.

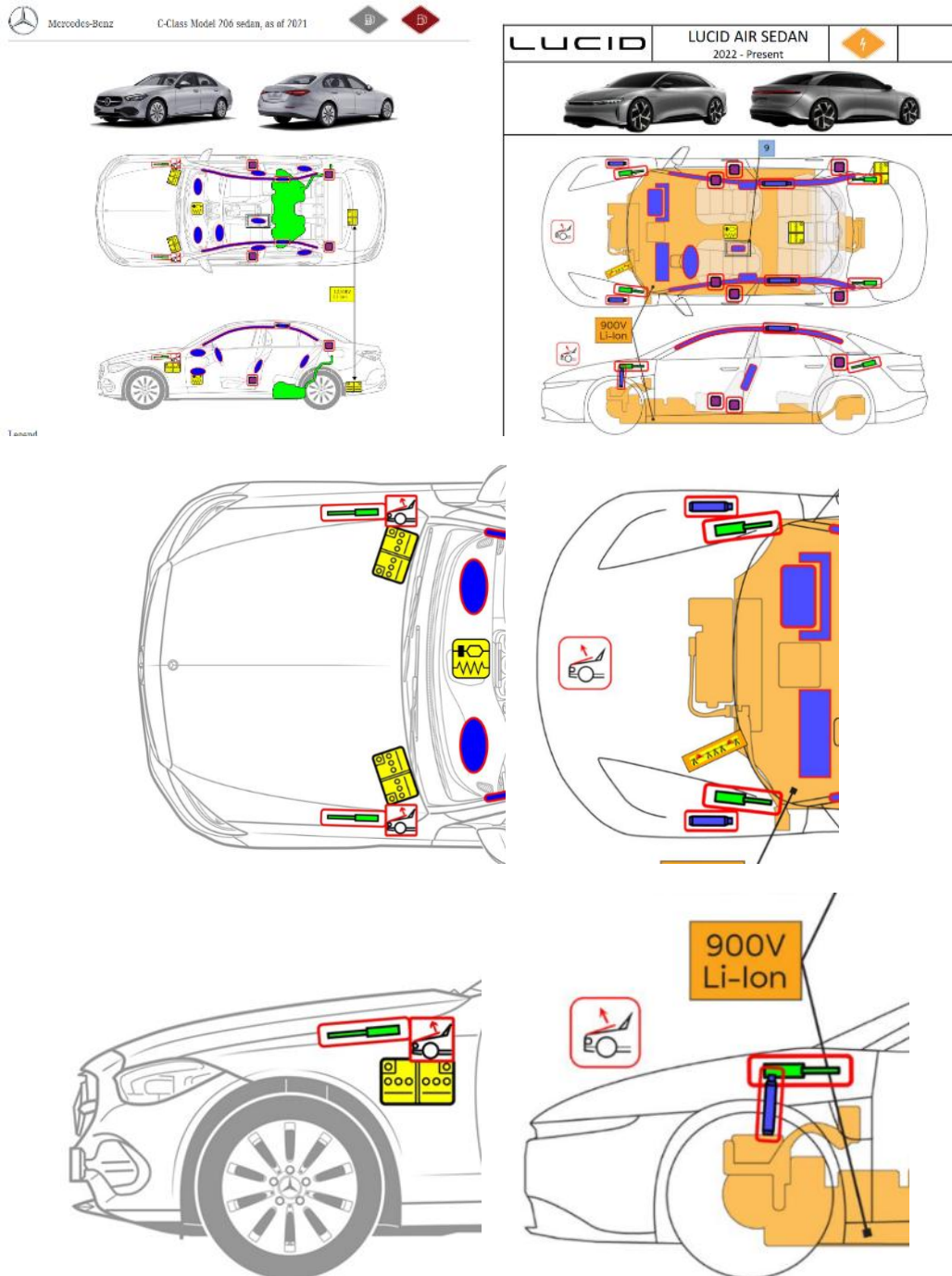

### 3.2.7 Reinforcements

The purpose of this information is to highlight structural reinforcements in the vehicle relevant to the rescue process, i.e., those structures that may be cut by the first responders to extricate the occupant. It can be used to highlight the reinforcements that can be used as a support to opening tools such as spreaders.

Reinforced structures can be difficult to cut because they may use high-strength steel or an accumulation of several layers of “standard steel”. For this reason, for instance, cutting the D-Loop area in the B-Pillar should normally be avoided.

Other types of reinforcements, such as inside the doors, are not relevant so it is not needed to present them.

### 3.2.8 Fuel Tank

A difference in the fuel type normally does not justify the creation of two distinct Rescue Sheets. In other words, one unique Rescue Sheet can cover Diesel and Gasoline variants. In such case, the fuel colour is to be used on the Top and Side View diagrams is based on the worst-case fuel type.













For instance, in the case of Diesel and Gasoline variants, the worst-case is Gasoline. For this reason, the dark red colour must be used in the top and side views. In any case, both diamonds (propulsion energy labels) must be displayed on the title part, so the first responders will know that this Rescue Sheet applies to both cases.

ISO 17840 Task Force is working on new pictograms, especially the ones for new energy symbol (the diamond one) such as liquified Hydrogen.











## 3.3 Legend

The legend of ISO 17840-Part 1:2022 **is a dynamic legend where only the pictograms used on the rescue sheet will have to be displayed.** (Older versions of ISO compliant rescue sheets already accepted by Euro NCAP would not be required to be updated to meet the latest ISO standard for the legend. But the new rescue sheets from 2023 onwards must follow the Part1:2022 definition).

Examples of dynamic legends:

|   |  |  |  |
|---|--|--|--|
|  Airbag                              |  Stored gas inflator                              |  Seat belt pretensioner |  SRS control unit                 |
|  Battery low voltage                 |  Gas strut /Preloaded spring                      |  High strength zone     |  Zone requiring special attention |
|  Air tank                            |  Low voltage device that disconnects high voltage |  Cable cut              |  High voltage battery pack        |
|  High voltage power cable /component |  |  |  |



|   |                            |   |   |   |                        |
|---|----------------------------|---|---|---|------------------------|
|  | Airbag                     |  | Stored gas inflator                               |  | Seat belt pretensioner |
|  | Gas strut/Preloaded spring |  | High strength zone                                |  | SRS control unit       |
|  | Battery low voltage        |  | High voltage power cable                          |  | High voltage component |
|  | Battery pack, high-voltage |  | High voltage device that disconnects high voltage |   |                        |

### 3.4 Footer

Check the following:

- 1) The document I.D. number is included. (This I.D. number can be the OEM internal file reference number).
- 2) The total number of pages of the Rescue Sheet must be listed in the footer.

## 4 ADDITIONAL PAGES LAYOUT AND CONTENT

Additional information is organised in Chapters. The relevant headings with colours, are shown below. The RGB colours (the text colour and the background colour) are imposed by ISO 17840 Part 3. The Rescue Sheet with additional information should not exceed 4 pages (including the front page). 5 pages when justified is also acceptable.

|  |
|--|
| 1. Identification / recognition                |
| 2. Immobilisation / stabilisation / lifting    |
| 3. Disable direct hazards / safety regulations |
| 4. Access to the occupants                     |
| 5. Stored energy / liquids / gases / solids    |
| 6. In case of fire                             |
| 7. In case of submersion                       |
| 8. Towing / transportation / storage           |
| 9. Important additional information            |
| 10. Explanation of pictograms used             |

If there is no specific information to give in one chapter, then the header of the chapter does not need to be displayed. But the next chapter will keep the chapter number as displayed above. There is no renumbering. However, if a hazard is applicable to several chapters, the general principle is that it should be repeated under each chapter.

Euro NCAP expects that for BEV, HEV, PHEV, Hydrogen, Fuel Cell powered vehicles that almost all chapters will be completed. Even for a traditional ICE (Internal Combustion Engine e.g. Diesel or Gasoline) vehicle, some information is relevant to be presented in the Rescue Sheet, such as:

- 48 Volt battery,
- New type of airbags (such as Occupant to Occupant Side Airbag),
- Other new active safety or passive safety technology/items,
- Special constructions/materials that has been used,
- New types of access to the vehicle,
- New types of communication V2X, etc.

Remember that the ISO 17840 Emergency Response Guide is made to be used as a direct link with the ISO 17840 Rescue Sheet to give further in-depth information. The combination of the two documents therefore can be very effective.

## 4.1 General

It is recommended that each of the additional page contains a small header listing: the brand / model / type and validity.

## 4.2 Chapter 1 – Identification / Recognition

### 1. Identification / recognition

When applicable, please start with the following warning (for Electric, Hybrid, Fuel Cell vehicles):

LACK OF ENGINE NOISE DOES NOT MEAN VEHICLE IS OFF: SILENT MOVEMENT OR INSTANT RESTART CAPABILITY EXISTS UNTIL VEHICLE IS FULLY SHUT DOWN. WEAR APPROPRIATE PPE.

- 1) General safety remarks are needed to approach safely the vehicle and give the possibility to identify/recognize safely the vehicle model.
- 2) All relevant information with applicable symbols/drawings/pictures/photos for the full identification of the vehicle. Information concerning symbols, model name, etc. on the vehicle, such as brand logo, model logo.
- 3) Information to identify the propulsion system:
  - Information of what to identify under the hood,
  - Information of what to identify on the dashboard,
  - Specific information to recognize this vehicle (e.g., hybrid, EV, FCEV, or other identification),
  - Specific REESS or alternative propulsion fluid / energy source,
  - Identification of the type of battery: chemistry family, voltage class, location in vehicle,
  - Inclusion of applicable ISO 17840 pictograms.

### EXAMPLE

#### 1. Identification / recognition

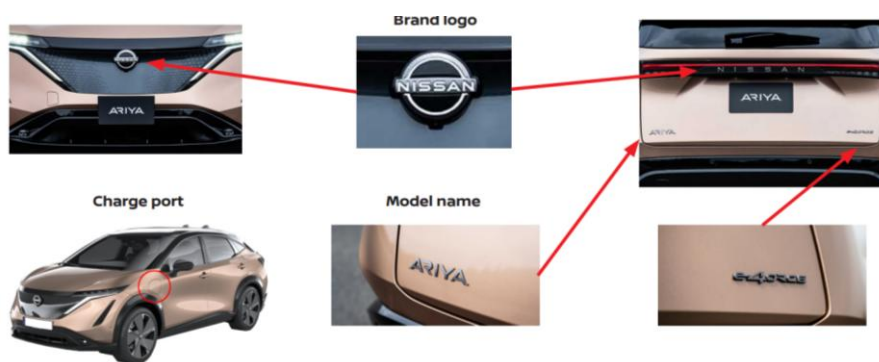

Source: Nissan.

## 4.3 Chapter 2 – Immobilisation / Stabilisation / Lifting

- 1) Show relevant information for immobilisation and/or stabilisation actions on/around the vehicle.
  - Provide images/illustrations of these elements,
  - Identify appropriate vehicle specific stabilisation-lifting points,
  - Identify prohibited vehicle specific stabilisation-lifting points.
- 2) It is recommended to separate the two main items, as follows:
  - A. **IMMOBILISE THE VEHICLE.** Generally, recommend to:
    - Block the wheels,
    - Set the parking brake,
    - Put the car in “P” for automatic gearbox,
    - Use pictures to show parking brake,
    - location and gear lever location.
  - B. **LIFTING POINTS.** Generally, a bottom view of the car to show the jack points and the High Voltage cables, if anyUse the titles above (A and B) to be consistent with other Rescue Sheets.

### EXAMPLE

#### 2. Immobilisation / stabilisation / lifting

##### Immobilise vehicle:

1. Block wheels and set parking brake;
2. Push the P (park) button to select the P (park) position;

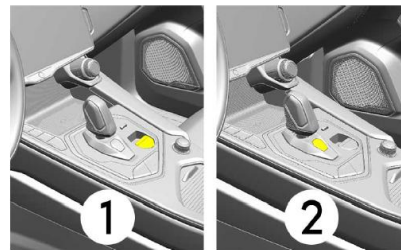

Source: LYNK&CO

##### Stabilisation-lifting points:

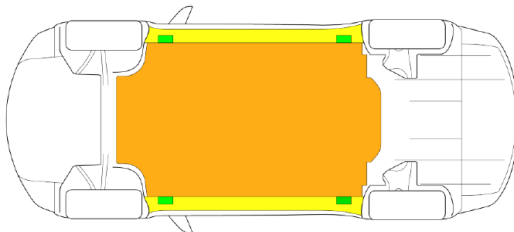

Source: TESLA

- Appropriate stabilisation-lifting points
- Appropriate stabilisation points vehicle on side
- High voltage battery

## 4.4 Chapter 3 – Disable Direct Hazards / Safety Regulations

### 4.4.1 Instructions in Rescue Sheet

#### 3. Disable direct hazards / safety regulations

- 1) Use as little text as possible to avoid language difficulties. Extensive use of the pictograms from ISO 17840-Part 3 is recommended. These pictograms can be on the left side of the page to symbolise the actions to take and where to do them.
- 2) **Any action to disable the energy in the vehicle must be represented by a pictogram on the vehicle diagram on page 1, in the legend on page 1 and in chapter 3. Pictograms that are not relevant for the first responders should not appear in the car diagram, legend or chapter 3 of the rescue sheet.**
- 3) It is important as well to define if the disabling process needs to be done with PPE, or not. Extra care should be taken of the correct use of the following:



Disconnect High Voltage Device (HVD)

To identify HVD that disconnect the high voltage where appropriate PPE is needed for the action

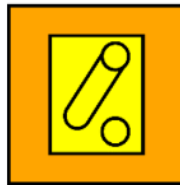

Disconnect High Voltage Device (HVD)\*

To identify the low voltage device that disconnect the high voltage (No PPE required)

\* the ON/OFF button or the key switch cannot be represented as well by this symbol as shown in the example on the next page.

- 4) Generally, there are some main actions and then some different alternatives for the hazard disabling. Clearly identify MAIN and ALTERNATIVE disabling methods as well as how to ACCESS the low voltage battery if needed:
  - MAIN DISABLING METHOD
  - ALTERNATIVE DISABLING METHOD(S)
  - ACCESS to low voltage battery

Use the text above as sub-headings in chapter 3 to be consistent with other rescue sheets.

- 5) Recommended content for this Chapter includes:
  - How to eliminate immediate danger, which safety requirements are needed.
  - Including “main” procedure and “alternative” procedure(s) for disabling direct hazards (e.g., disabling high voltage or shutting off gas pressure);
  - Procedure when EV / PHEV are connected on charging.
  - Illustrate “specific type” of disconnections, with necessary information.

## EXAMPLES



Source: ŠKODA

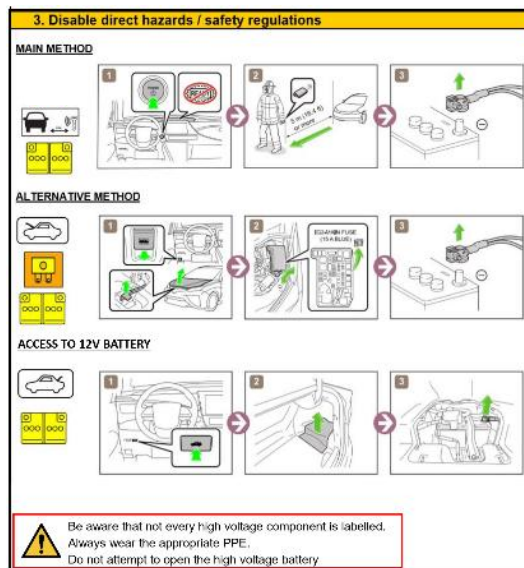

Source: Toyota

If vehicle is charging, disconnect charger.



Source: Lucid

### 4.4.2 Identification of Direct Hazard Disabling equipment in the vehicle (Energy Disabling Labels)

Labels identifying the component to be used to disable the direct hazard, such as high voltage, by the first responders should use the pictogram shown in the rescue sheet on page 1 vehicle diagram, legend and chapter 3. See section 4.3.1 – 2). This pictogram must be combined with the firefighter helmet symbol, appropriate background ISO energy colour and the action to be taken as per the protocol section 5.6.1.

Examples:





The firefighter helmet should always be the first pictogram visible from either side of the label if the label is folded around a wire etc. The photos below illustrate the issue where the firefighter helmet is not visible if the label is seen from the other side.



A solution when using a folded label would be to mirror the helmet at the end of the label.

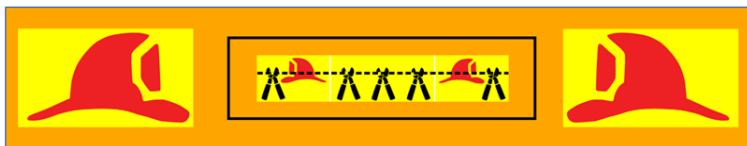



The firefighter helmet may be replaced with another firefighter helmet appropriate to cultural requirements.



### 4.4.3 Difference between ISO Pictograms and Energy Disabling labels

The pictograms as defined by ISO should not be modified in the rescue sheets by the OEM because there is a label in the vehicle.

The ISO pictograms should appear in the vehicle diagram and legend. This pictogram should be used in the labels attached to the vehicle. An example of a modified and incorrect pictogram shown in the legend (and vehicle diagram) is shown below, the firefighter helmet has been added to ISO pictogram. Rescue sheet would not be accepted in this case.

|   |   |   |  |
|---|---|---|--|
|  | <p>Low voltage device that disconnects high voltage</p> |  | <p>High voltage disconnect (cable cut)</p> |
|---|---|---|--|

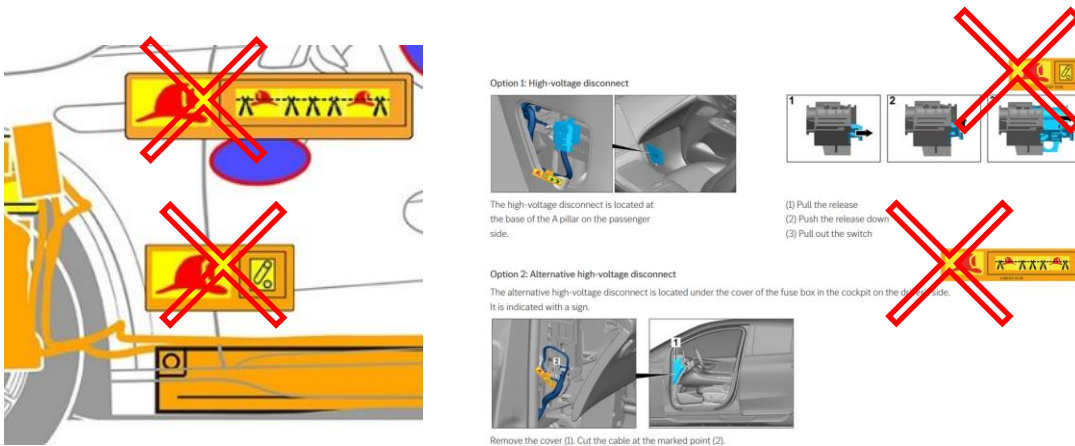



## 4.5 Chapter 4 – Access to the Occupants

### 4. Access to the occupants

1) Identify glass types (All windows): Laminated and Tempered glass.

It is also possible to add information in this chapter in case the car has very specific or distinct features, that are not present or located in the same place as most other cars, or that are not operated in the usual way. For this reason, in addition to 1), information could be included, such as:

- 2) Door latches/command.
- 3) Opening of the tailgate
- 4) High strength steel in body.
- 5) Seat adjustment operation (electric/mechanical).
- 6) Seat back adjustment range.
- 7) Steering column adjustment.

#### EXAMPLE of glass type

##### Glass types:

- A. Laminated glass.
- B. Tempered glass.

Source: Lynk & Co

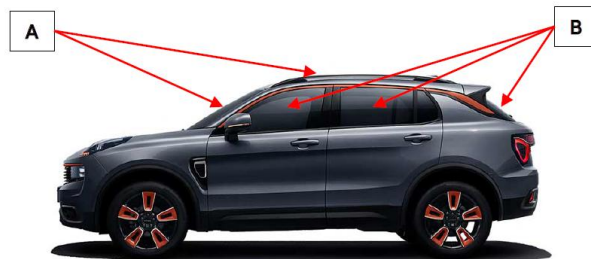

#### EXAMPLE of door latches

### 4. Access to the occupants

#### Interfaces

- 1 Interfaces in order to remove the roof
- 2 Door lock
- 3 Door hinge

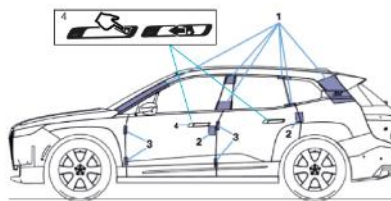

#### Mechanical emergency release

- 4 External mechanical handle
- 5 Internal mechanical handle

EXAMPLE of glass type AND door latches

**4. Access to the occupants**

|   |                        |   |                                    |
|---|------------------------|---|------------------------------------|
| A | Laminated              | B | Tempered                           |
| C | Outside Release Handle | D | Inside Release Handle (pull twice) |

The example above should fully explain the information first shown on page 1 of the rescue sheet regarding supplementary mechanical door handles.

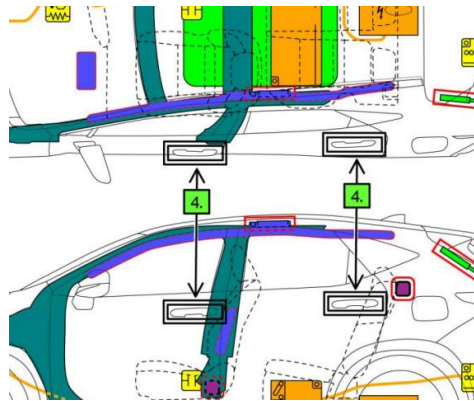

EXAMPLE of Seat back adjustment range

POSSIBLE MOVEMENT OF SEATS

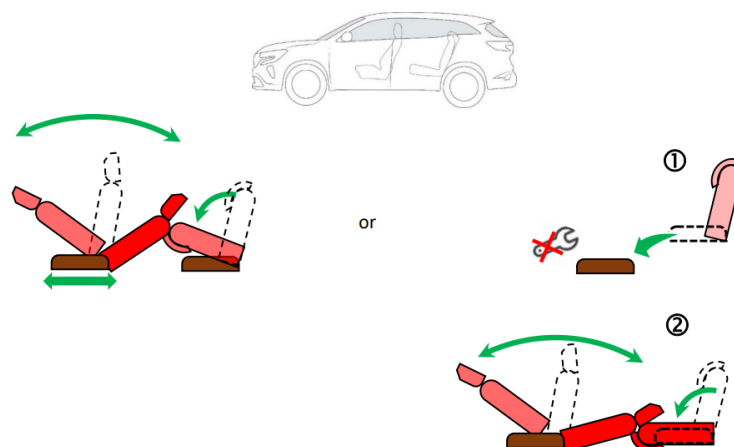

## 4.6 Chapter 5 – Stored Energy / Liquids / Gases / Solids

### 5. Stored energy / liquids / gases / solids











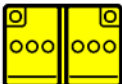

Focus on the following key points:

- 1) Primarily use pictograms here. A more detailed table will be available in the ERG so it is not needed in the Rescue Sheet.
- 2) List of stored energy/ liquids/Gases/Solids with mention of the dangers with the use of ISO 17840 pictograms:
  - Batteries with mention of voltage.
  - Propulsion fuel tank with mention of content in litre.
  - Propulsion gas tanks with mention of content in litre.
  - Solar cells with mention of voltage.
  - Carbon / Magnesium / Titanium used in vehicle.
  - Dangers when broken/leaks/dust (e.g Carbon fibres).
  - HV battery pack coolant.
  - Specific air-conditioning coolant.

Do not mention braking fluids, motor oil, etc. if they do not present any specific hazard.

- 3) For specific materials mentioned above, the location must be displayed on the front page with a double frame rectangle and the reference to this chapter (see also Double Frame Rectangle, page 10).

#### EXAMPLE

|   |  |           |
|---|--|-----------|
|  |   | Full body |
|  |   | 48 V      |
|  |  | 400V      |
|  |   | 700 bar   |
|  |   | 50 l      |
|  |   | 0,9 l     |



When coolant leaks from the battery pack, it can become unstable with risk of thermal runaway. Check battery pack temperature with thermal imaging camera.



















## 4.7 Chapter 6 – In Case of Fire

### 6. In case of fire

- 1) Again, mainly use pictograms here.
- 1) Extinguish method: recommendations specific for this type/model (e.g.)
  - Vehicle manufacturers should not recommend only one unique specialised extinguishing method/equipment that may not be available to all rescue services across Europe.
  - How to put water into the HV battery (e.g., Fireman access, direction of jet of water for better efficiency, dedicated actions when using specialised extinguishing method/equipment ...);
  - Clear warning if it is not recommended to apply a certain methodology to extinguish fire (e.g., not to put the car into container with water).
- 2) Hazards specific for this type/model.
- 3) Hazards also after fire (e.g., Carbon Fibres, reignition).
- 4) Recommendations specific for this model e.g., venting direction of the CNG, LNG, LPG or H2 or of the HV battery, if any.

### EXAMPLES

|                   |   |
|-------------------|---|
| Electric Powered  | <b>6. In case of fire</b>   |
|                   |  <span style="font-size: 1.2em; font-weight: bold; margin-left: 10px;">Use large amount of water</span>  |
|                   |      |
|                   |  <span style="font-size: 1.5em; font-weight: bold; margin-left: 10px;">!</span> <span style="font-size: 1.2em; font-weight: bold; margin-left: 10px;">BATTERY RE-IGNITION!</span>  |
| CNG Powered       | <b>6. In case of fire</b>   |
|                   | Temperature Pressure Release Device(TPRD) opens at 110°C (loud hissing noise)  <br>90 seconds before all CNG gas is released from a tank  |
| Fuel Cell Powered | <b>6. In case of fire</b>   |
|                   | Temperature Pressure Release Device(TPRD) opens at 110°C (loud hissing noise)    |
|                   |  <span style="font-size: 0.8em; font-weight: bold; margin-left: 10px;">USE LARGE AMOUNT OF WATER ON BATTERY PACK</span>  |
|                   |      |
|                   |  <span style="font-size: 1.2em; font-weight: bold; margin-left: 10px;">BATTERY RE-IGNITION</span>  |

Example of additional information to warn about the gas strut behaviour in case of fire:

6. In case of fire



Use large amount of water



**BATTERY RE-IGNITION!**

- Gas Strut/ Preloaded spring



Risk of missile effect of hood and tailgate

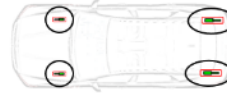

## 4.8 Chapter 7 – In Case of Submersion

### 7. In case of submersion

- 1) In most cases, a reference to Chapter 3 will suffice.
- 2) Where specific functions exist in the vehicle, addition information can be presented here, such as:
  - What to do in case of immersion in water, the specific dangers.
  - Which procedure to follow concerning e.g. high voltage.

#### EXAMPLE

### 7. In case of submersion

Wear appropriate PPE. Remove the vehicle from the water and continue with normal high voltage (see chapter 3). Vehicles submerged in salt water should be handled with a greater potential risk of a HV battery fire.

Tilt the vehicle to one side to allow water to drain out of the vehicle and the high voltage battery.

## 4.9 Chapter 8 – Towing / Transportation / Storage

### 8. Towing / transportation / storage

This section is specially made for second responders like towing services, garage technicians, etc. Focus on the following key points:

- 1) Present where to secure the towing hook tool in the car (front and rear) and if relevant where the tool is located:
  - Towing/transportation method specific for this type/model or general.
  - Storage method specific for this type/model or general.
  - Hazards and recommendations specific for this type/model or general.

#### EXAMPLE

### 8. Towing / transportation / storage

Location front hook



Location rear hook



**STORE AT SAFE DISTANCE FROM OTHER VEHICLES!**



**BATTERY RE-IGNITION!**



## 4.10 Chapter 9 – Important Additional Information

### 9. Important additional information

Standard information that can be displayed here is:

- 1) Contact information manufacturer.
- 2) Link to ERG (effective working link).

In addition, this chapter can be used to share more details about new to market technology, such as the deployed state of a new airbag system (roof airbag for instance).

- 3) Attention can be drawn to the first responders using a double frame rectangle and the reference to this chapter (or to Chapter 3) that will be displayed on the front page (see 3.2.2).















## 4.11 Chapter 10 – Explanation of Pictograms Used

### 10. Explanation of pictograms used

When there is enough space to fit this chapter inside the Rescue Sheet, it is good practice to insert a table with all the pictograms that are not yet presented in the legend displayed in the 1<sup>st</sup> page.

Otherwise, if not possible, insert the link to the ISO 17840 ERG where they can be displayed and defined.

### EXAMPLE

| 10. Explanation of pictograms used  |                                 |   |   |
|---|---------------------------------|---|---|
|  | Smart key distance              |  | Risk of flammability                    |
|  | Warning high voltage            |  | Risk of damaging human health           |
|  | Caution                         |  | Risk of acute toxicity                  |
|  | Warning low temperature         |  | Risk of an explosion                    |
|  | Air-conditioning component      |  | Risk of corrosive material / substances |
|  | Hybrid Gasoline vehicle         |  | Use water to extinguish the fire        |
|  | Use IR Camera (thermal imaging) |  | Bonnet                                  |
|   |                                 |  | Trunk                                   |

# 5 ERG – EMERGENCY RESPONSE GUIDE

ERG is expected to give more details of each item already present in the Rescue Sheet. For this reason, all the recommendations given in the previous chapter are also applicable here.

In accordance with ISO 17840 Part 3, Chapter 0 should list the Rescue sheets covered by this ERG, but there is no need to include each of the rescue sheets in chapter 0. Since an ERG may cover more than one energy propulsion technology, it is strongly recommended to use the diamond symbols from ISO 17840 Part 4; to easily recognise which technology the section is about. This is the same philosophy for the use of other pictograms such as “solar panel” or “fuel cell” that are already available in ISO 17840 Part 3 and that can easily identify a section in the ERG document.

Some OEMs have decided that the Service Plug is not to be used to deactivate the HV in case of an accident. This is something to clearly mention in ERG, when it is the case (for example having a dedicated section starting with “For Service Maintenance only”).

## 5.1 Overview of ERG headings (RGB colours see ISO 17840 part 2, 3).

### CONTENTS

|  |      |
|--|------|
| 0. Rescue Sheet                                | Page |
| 1. Identification / recognition                | Page |
| 2. Immobilization / stabilization / lifting    | Page |
| 3. Disable direct hazards / safety regulations | Page |
| 4. Access to the occupants                     | Page |
| 5. Stored energy / liquids / gases / solids    | Page |
| 6. In case of fire                             | Page |
| 7. In case of submersion                       | Page |
| 8. Towing/transportation / storage             | Page |
| 9. Important additional information            | Page |
| 10. Explanation pictograms used                | Page |

Specific chapter in ERG

Source ISO 17840

Headings with page number filled in

Source ISO 17840



## 5.2 Emergency Response Guide -Chapter 0

This is chapter 0 that is meant to identify which vehicle model(s) and thus to which rescue sheet(s) this ERG is applicable.

Expected information: Only the first page of each Rescue Sheet or just a list, if there are too many vehicles to which this ERG is applicable.

## 5.3 Emergency Response Guide - following chapters

For each chapter, add the following key points from the ones already described in the Rescue Sheet Chapter:

- 1) Use pictograms/drawings/pictures of the rescue sheet you have made but now given in dept information/explanation.
- 2) These pictograms can be on the left side of the page to symbolise the actions to take and where to do them.

### 1. Identification / recognition

When applicable, please start with the following warning (for Electrified vehicles):

LACK OF ENGINE NOISE DOES NOT MEAN VEHICLE IS OFF: SILENT MOVEMENT OR INSTANT RESTART CAPABILITY EXISTS UNTIL VEHICLE IS FULLY SHUT DOWN. WEAR APPROPRIATE PPE.

### 3. Disable direct hazards / safety regulations

In addition to the TB030 rescue sheet section:

Provide detailed images of “specific type” hazards disabling, with necessary information.

- 1) Procedure when vehicle is connected on charging.  
Provide detailed images of “specific type”, with necessary information
- 2) How to close valves and different valves.  
Provide detailed images of “specific type”, with necessary information.

### 4. Access to the occupants

In addition to the TB030 rescue sheet section:

- 1) Detailed vehicle drawing with:
  - Structure
  - Thickness of structure
  - Used materials in structure
  - Key structure points

## 5. Stored energy / liquids / gases / solids

In addition to the TB030 rescue sheet section:

- 1) List of stored energy / liquids/ gases / solids with mention of the dangers with the use of ISO 17840 pictograms:
  - Oil tanks - state capacity in litres.

## 6. In case of fire

In addition to the TB030 rescue sheet section:

- 1) Recommended content for this chapter includes:
  - How to eliminate immediate danger (s), which safety requirements are needed.
  - Hazards specific for this type/model.
  - Dangers of inhalation.
- 2) Automatic fire suppression system: when and how it works.
- 3) Treatment of wastewater.
- 4) For specific materials mentioned above, the location must be displayed on the front page with a double frame rectangle and the reference to this chapter (see also double frame rectangle).

## 9. Important additional information

Additional information about new and uncommon technology provided in the vehicle that has a consequence for rescue operations, e.g., LNG or hydrogen installation.

This is very important to mention, so the responder can be trained **BEFORE** and not confronted on the scene of the incident.

## 10. Explanation pictograms used

Explanation of all the pictograms used in the ERG.

## 6 RESCUE SHEET & ERG - FILE NAMING STEP BY STEP GUIDE

The OEM must ensure that the filename of a rescue sheet and the vehicle picture follows the exact Euro NCAP naming convention in order for it to be accepted and automatically uploaded to the Euro Rescue App. A simple Excel file naming tool with drop down menus is available for download from the Euro NCAP website: [www.euroncap.com/en/for-engineers/supporting-information/](http://www.euroncap.com/en/for-engineers/supporting-information/). This file can be used as a guide to generate the correct filename when using the drop down menus to describe the particular model covered by the rescue sheet.

Example file naming - Rescue Sheet filename required for 2017 Skoda Kodiaq RS 5dr SUV Diesel:

**Make** – Select make from drop down menu

|                           |   |            |
|---------------------------|---|------------|
| <i>With:</i>              |   |            |
| <b>Make</b>               | Choose from list to ensure correct spelling                                 | Skoda      |
| <b>ModelName</b>          | General model name  | Skoda      |
| <b>ModelNameExtension</b> | Additional description in model name (if applicable, otherwise leave empty) | smart      |
| <b>BodyStyle</b>          | Choose from list  | SsangYong  |
| <b>BuildYearFrom</b>      | As mentioned in Rescue Sheet  | Subaru     |
| <b>NrDoors</b>            | Choose from list  | Suzuki     |
| <b>Powertrain</b>         | Choose from list  | Tesla      |
| <b>Language</b>           | EN, DE, FR, ES  | Toyota     |
|                           |   | Volkswagen |
|                           |   | EN         |

**Model Name** – Type in General model name (NOT full name with trim, engine capacity etc)

|                           |   |        |
|---------------------------|---|--------|
| <i>With:</i>              |   |        |
| <b>Make</b>               | Choose from list to ensure correct spelling                                 | Skoda  |
| <b>ModelName</b>          | General model name  | Kodiaq |
| <b>ModelNameExtension</b> | Additional description in model name (if applicable, otherwise leave empty) | RS     |
| <b>BodyStyle</b>          | Choose from list  | SUV    |
| <b>BuildYearFrom</b>      | As mentioned in Rescue Sheet  | 2017   |
| <b>NrDoors</b>            | Choose from list  | 5d     |
| <b>Powertrain</b>         | Choose from list  | GD     |
| <b>Language</b>           | EN, DE, FR, ES  | EN     |

**Model Name Extension** – Type additional description which helps identify the specific variant or version the rescue sheet covers (if not needed LEAVE BLANK, file naming macro will generate correct filename)

|                           |   |        |
|---------------------------|---|--------|
| <i>With:</i>              |   |        |
| <b>Make</b>               | Choose from list to ensure correct spelling                                 | Skoda  |
| <b>ModelName</b>          | General model name  | Kodiaq |
| <b>ModelNameExtension</b> | Additional description in model name (if applicable, otherwise leave empty) | RS     |
| <b>BodyStyle</b>          | Choose from list  | SUV    |
| <b>BuildYearFrom</b>      | As mentioned in Rescue Sheet  | 2017   |
| <b>NrDoors</b>            | Choose from list  | 5d     |
| <b>Powertrain</b>         | Choose from list  | GD     |
| <b>Language</b>           | EN, DE, FR, ES  | EN     |

## Body Style – Select one from drop down menu

|  |   |
|--|---|
| <b>Filename</b>                        | [Make]_[ModelName]_[ModelNameExtension]_[BodyStyle]_[BuildYearFrom]_[NrDoors]_[Powertrain]_[Language] |
| <b>Example RescueSheet filename</b>    | Skoda_Kodiaq_RS_SUV_2017_5d_GD_EN.pdf   |
| <b>Example Response Guide filename</b> | Skoda_Kodiaq_RS_SUV_2017_5d_GD_EN_ERG.pdf   |
| <b>Example Picture filename</b>        | Skoda_Kodiaq_RS_SUV_2017_5d_GD.png  |
| <i>With:</i>                           |   |
| <b>Make</b>                            | Choose from list to ensure correct spelling   |
| <b>ModelName</b>                       | General model name  |
| <b>ModelNameExtension</b>              | Additional description in model name (if applicable, otherwise leave empty)                           |
| <b>BodyStyle</b>                       | Choose from list  |
| <b>BuildYearFrom</b>                   | As mentioned in Rescue Sheet  |
| <b>NrDoors</b>                         | Choose from list  |
| <b>Powertrain</b>                      | Choose from list  |
| <b>Language</b>                        | EN, DE, FR, ES  |

## Build Year From – Type in year from which this vehicle is built

|                           |   |
|---------------------------|---|
| <i>With:</i>              |   |
| <b>Make</b>               | Choose from list to ensure correct spelling                                 |
| <b>ModelName</b>          | General model name  |
| <b>ModelNameExtension</b> | Additional description in model name (if applicable, otherwise leave empty) |
| <b>BodyStyle</b>          | Choose from list  |
| <b>BuildYearFrom</b>      | As mentioned in Rescue Sheet  |
| <b>NrDoors</b>            | Choose from list  |
| <b>Powertrain</b>         | Choose from list  |
| <b>Language</b>           | EN, DE, FR, ES  |

## Number of Doors – Select one from drop down menu

|                           |   |
|---------------------------|---|
| <i>With:</i>              |   |
| <b>Make</b>               | Choose from list to ensure correct spelling                                 |
| <b>ModelName</b>          | General model name  |
| <b>ModelNameExtension</b> | Additional description in model name (if applicable, otherwise leave empty) |
| <b>BodyStyle</b>          | Choose from list  |
| <b>BuildYearFrom</b>      | As mentioned in Rescue Sheet  |
| <b>NrDoors</b>            | Choose from list  |
| <b>Powertrain</b>         | Choose from list  |
| <b>Language</b>           | EN, DE, FR, ES  |

**Powertrain** - Select one from drop down menu (app does not distinguish between a Gasoline or Diesel ICE, these are shown together in app even if there is no gasoline or diesel version available for this model)

|                                |   |
|--------------------------------|---|
| <i>With:</i>                   |   |
| <b>Make</b>                    | Choose from list to ensure correct spelling                                 |
| <b>ModelName</b>               | General model name  |
| <b>ModelNameExtension</b>      | Additional description in model name (if applicable, otherwise leave empty) |
| <b>BodyStyle</b>               | Choose from list  |
| <b>BuildYearFrom</b>           | As mentioned in Rescue Sheet  |
| <b>NrDoors</b>                 | Choose from list  |
| <b>Powertrain</b>              | Choose from list  |
| <b>Language</b>                | EN, DE, FR, ES  |
| <b>Powertrain explanation:</b> |   |
| GD                             | Gasoline and/or Diesel ICE  |
| Hybrid (Electric)              | Hybrid Electric with Gasoline or Diesel                                     |
| Electric                       | Full Electric vehicle   |
| FCEV                           | Fuel Cell Electric Vehicle on Hydrogen                                      |
| LPG                            | Liquidified Petroleum Gas   |
| CNG                            | Compressed Natural Gas  |
| LNG                            | Liquidified Natural Gas   |

## Language - Select one from drop down menu

|                    |   |        |
|--------------------|---|--------|
| With:              |   |        |
| Make               | Choose from list to ensure correct spelling                                 | Skoda  |
| ModelName          | General model name  | Kodiaq |
| ModelNameExtension | Additional description in model name (if applicable, otherwise leave empty) | RS     |
| BodyStyle          | Choose from list  | SUV    |
| BuildYearFrom      | As mentioned in Rescue Sheet  | 2017   |
| NrDoors            | Choose from list  | 5d     |
| Powertrain         | Choose from list  | GD     |
| Language           | EN, DE, FR, ES  | EN     |
|                    |   | EN     |
|                    |   | DE     |
|                    |   | FR     |
|                    |   | ES     |
|                    |   | IT     |

After inputting all of the required car model rescue sheet data the excel file will generate the following:

|                                 |  |
|---------------------------------|--|
| Filename                        | [Make]_[ModelName]_[ModelNameExtension]_[BodyStyle]_[Build YearFrom]_[NrDoors]_[Powertrain]_[Language] |
| Example Rescue Sheet filename   | Skoda_Kodiaq_RS_SUV_2017_5d_GD_EN.pdf  |
| Example Response Guide filename | Skoda_Kodiaq_RS_SUV_2017_5d_GD_EN_ERG.pdf  |
| Example Picture filename        | Skoda_Kodiaq_RS_SUV_2017_5d_GD.png   |

Example file naming - Rescue Sheet filename required for 2017 Skoda Kodiaq 5dr SUV for rescue sheet that covers **ALL** models in range and not just one specific variant:

Follow all the steps as previously shown except for the following:

### Model Name Extension – Leave cell blank

|                    |   |        |
|--------------------|---|--------|
| With:              |   |        |
| Make               | Choose from list to ensure correct spelling                                 | Skoda  |
| ModelName          | General model name  | Kodiaq |
| ModelNameExtension | Additional description in model name (if applicable, otherwise leave empty) |        |
| BodyStyle          | Choose from list  | SUV    |
| BuildYearFrom      | As mentioned in Rescue Sheet  | 2017   |
| NrDoors            | Choose from list  | 5d     |
| Powertrain         | Choose from list  | GD     |
| Language           | EN, DE, FR, ES  | EN     |

After inputting all of the required car model rescue sheet data the excel file will generate the following:

|                              |  |
|------------------------------|--|
| Filename                     | [Make]_[ModelName]_[ModelNameExtension]_[BodyStyle]_[Build YearFrom]_[NrDoors]_[Powertrain]_[Language] |
| Example RescueSheet filename | Skoda_Kodiaq__SUV_2017_5d_GD_EN.pdf  |

|                           |          |   |
|---------------------------|----------|---|
| Example<br>Guide filename | Response | Skoda_Kodiaq__SUV_2017_5d_GD_EN_ERG.pdf |
| Example<br>filename       | Picture  | Skoda_Kodiaq__SUV_2017_5d_GD.png        |

#### Facelifted model

If a car model is facelifted and the OEM believes that a new Rescue Sheet is required, they can do either of the following:

- Create a new rescue sheet with a new “Build Year From” in the filename. This rescue sheet will then appear as a new version of the car model in the rescue app. The older one will also be available.
- If the rescue sheet covers both the old model and the new face lifted model, the OEM should provide an updated rescue sheet with the exact same filename as the previous version and when uploaded it will replace the rescue sheet with the newer version in the app.

#### Vehicle not tested by Euro NCAP

If a car model has not been assessed by Euro NCAP and the OEM wishes for the rescue sheet to be included in the rescue app they should follow the file naming convention, submit a copy of the rescue sheet and car photos just as they would normally do for a car tested by Euro NCAP.